

Article number: 201623B182SW

Description: E+G Swivel clamp - GN 162.3-B18-2-SW

## Measures

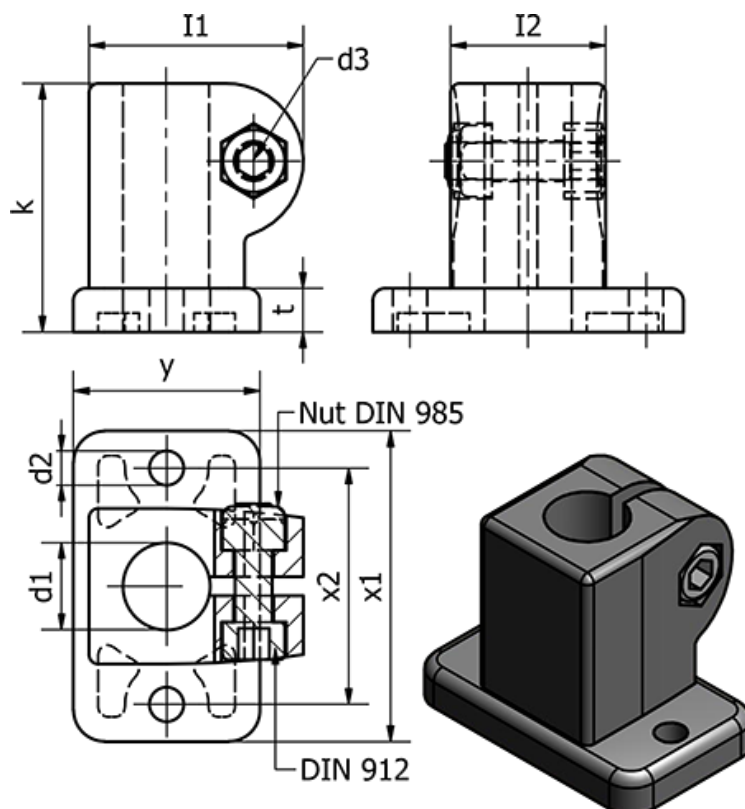

Clamping kit for d3 = GN 911-M6-22

d1	= 18
d2	= 5.5
d3	= M6
I1	= 34.5
I2	= 25
k	= 40
t	= 7

Weight (g) = 61

x1	= 50
x2	= 38
y	= 30